

## Infrared Cameras

The most portable  
infrared online camera

- Temperature measurement -20°C to 1500°C
- Small cameras - Ideal for OEM applications
- Up to 128 Hz for fast processes
- Including software package and SDK
- High resolution of up to 382 x 288 pixels



## Automatic hot spot detection

Objects can be examined thermally and **hot or cold positions** (hot or cold spots) can be found automatically.

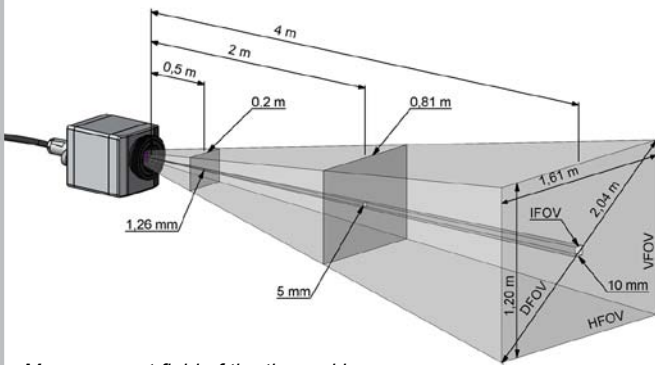

Measurement field of the thermal imager optris PI as an example with the standard lens 23° x 17°



## Fast measurements

Temperature distributions at surfaces can be captured precisely within a **millisecond interval**.

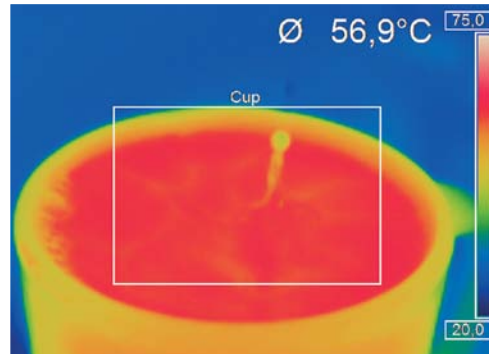

A milk drop falls into a coffee cup



## Portable and stationary

The cameras fill the existing gap between **portable** infrared snap shot cameras and pure **stationary** devices. Possible applications are for example:

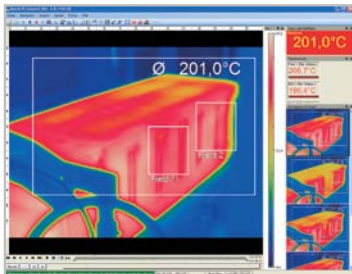

Process automation

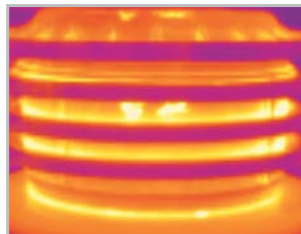

Test stations

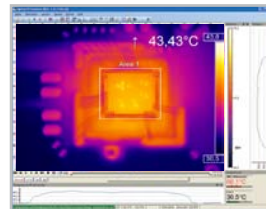

Research & Development



Portable measurement tasks



## Easy process integration

**Advanced interface concepts** allow the integration within networks and automated systems:

- USB cable extension up to 100 m (over Ethernet)

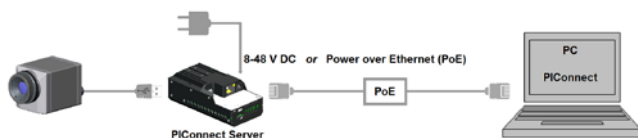

- Process interface (PIF) at the camera as analog input / output (0 to 10 V) and digital input (low- and high-level)
- Software Development Kit (SDK) for integration of the camera into customer specific software applications via Dynamic-link Library (DLL), COM-Port and LabVIEW



optris® PI160  
Thermal imager with 120 Hz frame rate



**Important Features**

- Outstanding price-performance ratio
- Detector with 160 x 120 pixel
- Thermal images in real time with up to 120 Hz
- Very good thermal sensitivity starting from 80 mK
- Small design (Size: 45 x 45 x 62 mm<sup>3</sup>)
- Industrial accessories
- Thermo Analysis Kit incl. 3 lenses (optional)

**Small camera - Ideal for OEM applications**

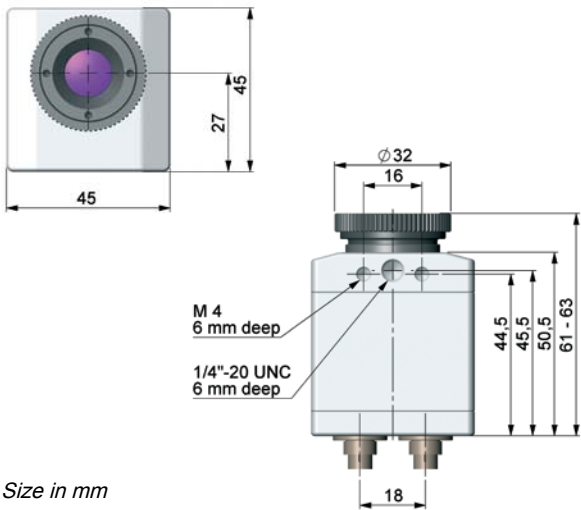

Size in mm

**Industrial Accessories**

The infrared cameras are available with a housing with **protection class IP 67 (NEMA-4)**. The use of the device takes place at the following temperatures...

- ... up to **50°C** without cooling housing
- ... up to **100°C** with cooling housing (air cooling)
- ... up to **240°C** with cooling housing (water cooling)

Additional industrial accessories is available, such as **USB high temperature cables** up to 20 m and mounting systems.



Cooling housing with air and water cooling option

**Fitting lenses for each distance**

**Hand as device under test**  
Measuring field size: 240 mm x 180 mm, pixel size: 1.5 mm

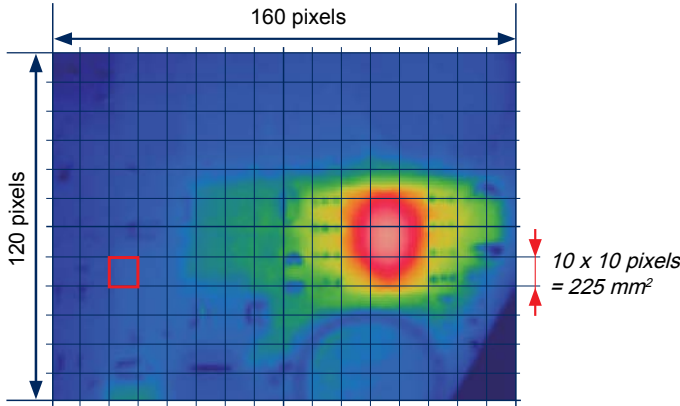

**Same measurement field size**  
using different lenses:

- Standard lens: 0.6 m measuring distance
- Tele lens: 2.13 m measuring distance
- Wide angle lens: 0.27 m measuring distance

Calculation of accurate measurement fields at our website <http://www.optris.com/optics-calculator>.



optris® PI200 / PI230  
Thermal imager with BI-SPECTRAL technology



**Important Features**

- BI-SPECTRAL technology
- Thermal images in real time with up to 128 Hz (160 x 120 pixel)
- Time synchronic visual image recording with up to 32 Hz (640 x 480 pixel)
- Low-light-level technology of visual camera
- Small design (Size: 45 x 45 x 62 mm<sup>3</sup>)
- Thermo Analysis Package incl. 3 lenses (optional)

**BI-SPECTRAL technology**

With the help of BI-SPECTRAL technology, a **visual image** (VIS) can be combined with a **thermal image** (IR). Both can be finally captured time synchronously:

**Monitoring modus:**

Easy orientation at point of measurement by separate display of visual image

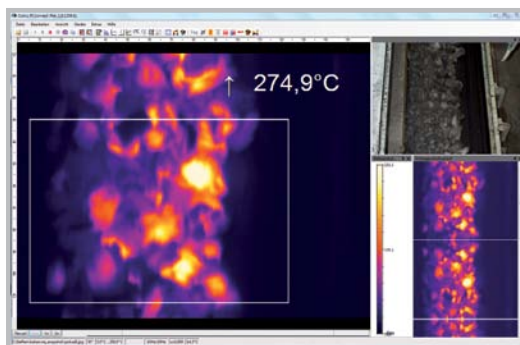

Monitoring of coal on conveyor belt

**Cross-fading modus:**

Highlighting of critical temperatures by cross-fading (0...100% transparency) ...

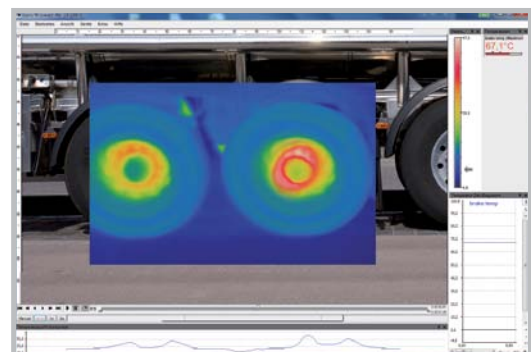

Measurement of break temperature in cross-fading modus

... or by cross-fading defined temperatures (thresholds)

**Two cameras in one compact device**

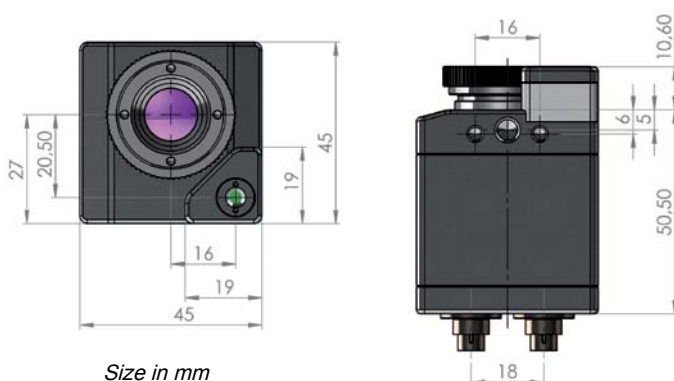

Size in mm

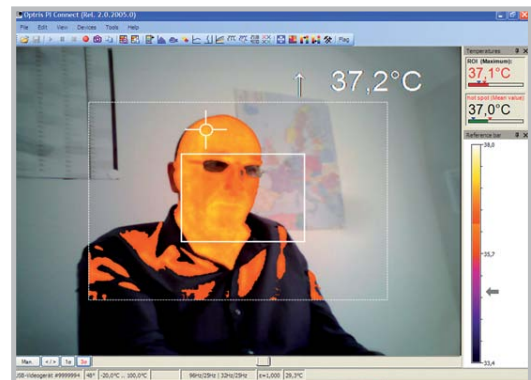

Cross-fading of VIS image above temperatures of 35°C

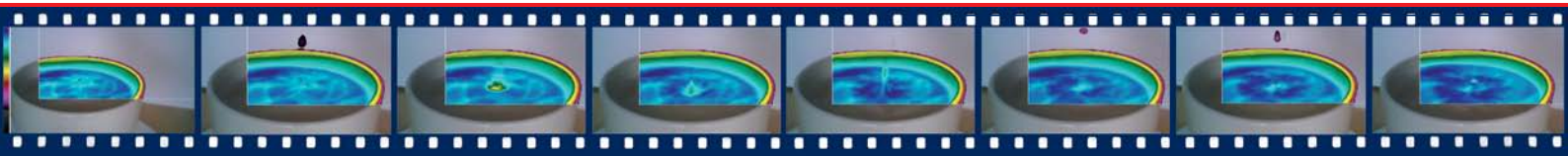

optris® PI400 / PI450  
Thermal imager with 382 x 288 pixels



**Important Features**

- Detector with 382 x 288 pixels
- Fast real-time thermal imager with up to 80 Hz
- Very high thermal sensitivity with 80 mK (PI400) and 40 mK (PI450)
- Smallest camera in its class (46 x 56 x 90 mm<sup>3</sup>)
- Lightweight (320 g incl. optics)
- Exchangeable lenses & industrial accessories

**Smallest camera in its class**

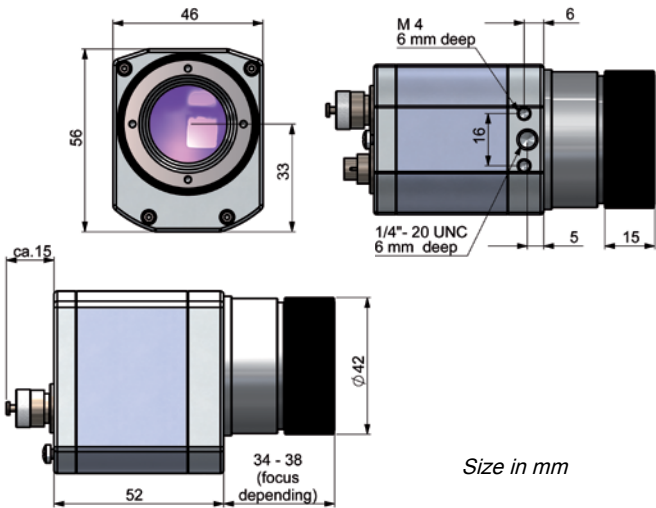

**High temperature resolution of 40 mK**

The optris PI450 offering a resolution of 40 mK is used to detect tiny temperature differences, for example in product quality inspections or medical prophylaxis.

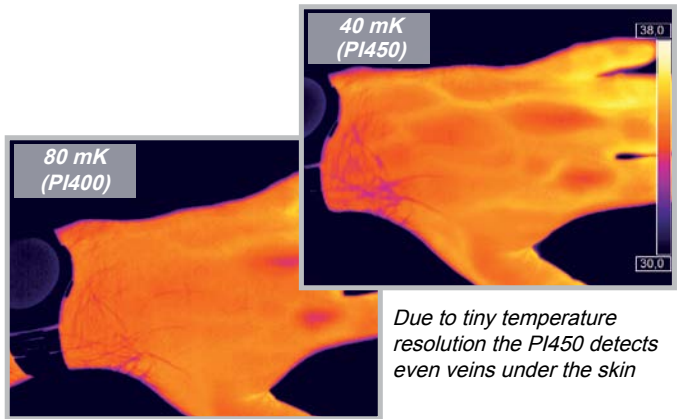

**80 Hz data capturing with high resolution**

**SMD part as measurement object:**  
Size of part: 32 mm x 24 mm, pixel size: 0.08 mm

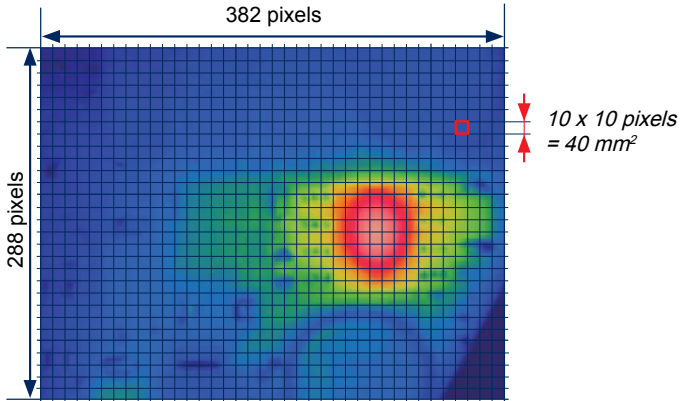

The camera displays and stores thermal images with high resolution (382 x 288 px) at full frame rate of 80 Hz (80 images per second).

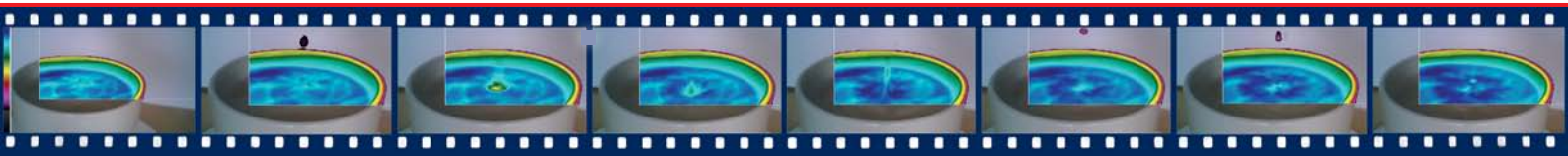
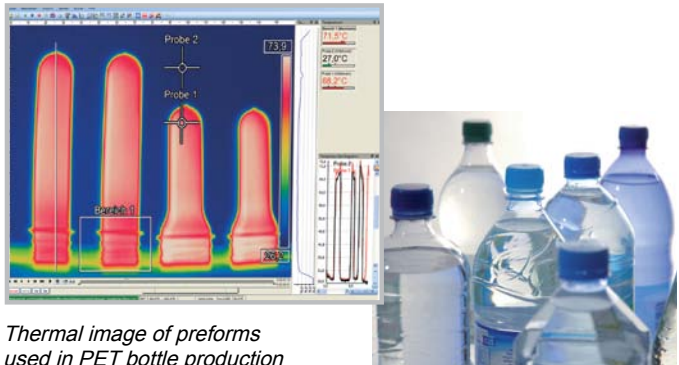

# Technical data of infrared cameras

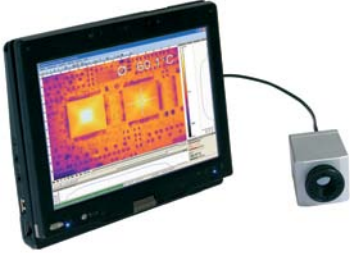
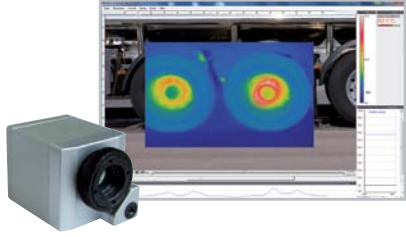
Basis model	PI160	PI200 / PI230
Type	IR	BI-SPECTRAL
		
Scope of supply	USB camera incl. 1 lens, USB cable (1 m), table tripod, PIF cable incl. terminal block (1 m), software package optris PI Connect, aluminum case	USB camera with 1 lens and BI-SPECTRAL technology, USB cable (1 m), table tripod, focussing tool, PIF cable incl. terminal block (1 m), software package optris PI Connect, aluminum case
Detector	FPA, uncooled (25 µm x 25 µm)	FPA, uncooled (25 µm x 25 µm)
Optical resolution	160 x 120 pixel	160 x 120 pixel
Spectral range	7.5 - 13 µm	7.5 - 13 µm
Temperature ranges	-20°C...100°C, 0°C...250°C, 150°C...900°C, additional range: 200°C...1500°C (option)*	-20°C...100°C, 0°C...250°C, 150°C...900°C, additional range: 200°C...1500°C (option)*
Frame rate	120 Hz	128 Hz***
Optics (FOV)	23° x 17° FOV / f = 10 mm <u>or</u> 6° x 5° FOV / f = 35.5 mm <u>or</u> 41° x 31° FOV / f = 5.7 mm <u>or</u> 72° x 52° FOV / f = 3.3 mm	23° x 17° FOV** / f = 10 mm <u>or</u> 6° x 5° FOV / f = 35.5 mm <u>or</u> 41° x 31° FOV** / f = 5.7 mm <u>or</u> 72° x 52° FOV / f = 3.3 mm
Thermal sensitivity (NETD)	0.08 K with 23° x 17° FOV / F = 0,8 0.3 K with 6° x 5° FOV / F = 1,6 0.1 K with 41° x 31° FOV and 72° x 52° FOV / F = 1	0.08 K with 23° x 17° FOV / F = 0,8 0.3 K with 6° x 5° FOV / F = 1,6 0.1 K with 41° x 31° FOV and 72° x 52° FOV / F = 1
Option for visual camera (only for BI-SPECTRAL camera)	-	Optical resolution: 640 x 480 Pixel Frame rate: 32 Hz*** Optics (FOV): 54° x 40° (PI200), 30° x 23° (PI230)
Accuracy	±2°C or ±2%	±2°C or ±2%
PC interface	USB 2.0	USB 2.0
Process interface (PIF)	0 - 10 V input, digital input, 0 - 10 V output	0 - 10 V input, digital input, 0 - 10 V output
Ambient temperature (T <sub>Amb</sub> )	0°C...50°C	0°C...50°C
Storage temperature	-40°C...70°C	-40°C...70°C
Relative humidity	20 - 80%, non condensing	20 - 80%, non condensing
Enclosure (size / rating)	45 mm x 45 mm x 62 mm / IP 67 (NEMA 4)	45 mm x 45 mm x 62 mm / IP 67 (NEMA 4)
Weight	195 g, incl. lens	215 g, incl. lens
Shock / vibration	25G, IEC 68-2-29 / 2G, IEC 68-2-6	25G, IEC 68-2-29 / 2G, IEC 68-2-6
Tripod mount	1/4-20 UNC	1/4-20 UNC
Power supply	USB powered	USB powered

## The optris PI160 / PI200 as Thermal Analysis Package

- Infrared camera optris PI160 or PI200
- 3 lenses (23°, 6°, 41°) incl. calibration certificate
- USB cable (1 m and 10 m)
- Table tripod (20 - 63 cm)
- PIF cable with terminal block (1 m)
- Software package optris PI Connect
- Aluminum case



\* The additional measurement range is not available for 72° HFOV optics

\*\* For ideal combination of IR and VIS image, a 41° HFOV lens is recommended (optris PI200). For the PI230, a 23° HFOV lens is recommended.

\*\*\* The following options can be set:  
Option 1 (IR with 96 Hz at 160 x 120 px; VIS with 32 Hz at 640 x 480 px)  
Option 2 (IR with 128 Hz at 160 x 120 px; VIS with 32 Hz at 596 x 447 px)



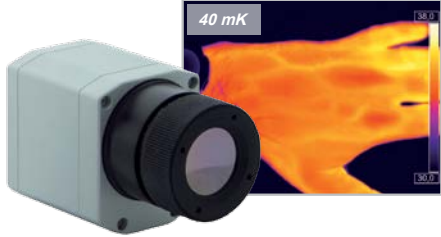

Basis model	PI400	PI450
Type	IR	IR
		
Scope of supply	USB camera incl. 1 lens, USB cable (1 m), table tripod, PIF cable incl. terminal block (1 m), software package optris PI Connect, aluminum case	USB camera incl. 1 lens, USB cable (1 m), table tripod, PIF cable incl. terminal block (1 m), software package optris PI Connect, aluminum case
Detector	FPA, uncooled (25 µm x 25 µm)	FPA, uncooled (25 µm x 25 µm)
Optical resolution	382 x 288 pixel	382 x 288 pixel
Spectral range	7.5 - 13 µm	7.5 - 13 µm
Temperature ranges	-20°C...100°C, 0°C...250°C, 150°C...900°C additional range: 200°C...1500°C (option)	-20°C...100°C, 0°C...250°C, 150°C...900°C
Frame rate	80 Hz	80 Hz
Optics (FOV)	38° x 29° FOV / f = 15 mm <u>or</u> 62° x 49° FOV / f = 8 mm <u>or</u> 13° x 10° FOV / f = 41 mm	38° x 29° FOV / f = 15 mm <u>or</u> 62° x 49° FOV / f = 8 mm <u>or</u> 13° x 10° FOV / f = 41 mm
Thermal sensitivity (NETD)	0.08 K with 38° x 29° FOV / F = 0.8 0.08 K with 62° x 49° FOV / F = 0.8 0.1 K with 13° x 10° FOV / F = 1.0	0.04 K with 38° x 29° FOV / F = 0.8 0.04 K with 62° x 49° FOV / F = 0.8 0.06 K with 13° x 10° FOV / F = 1.0
Option for visual camera (only for BI-SPECTRAL camera)	-	-
Accuracy	±2°C or ±2%	±2°C or ±2%
PC interface	USB 2.0	USB 2.0
Process interface (PIF)	0 - 10 V input, digital input, 0 - 10 V output	0 - 10 V input, digital input, 0 - 10 V output
Ambient temperature (T <sub>Amb</sub> )	0°C...50°C	0°C...70°C
Storage temperature	-40°C...70°C	-40°C...85°C
Relative humidity	20 - 80%, non condensing	20 - 80%, non condensing
Enclosure (size / rating)	46 mm x 56 mm x 90 mm / IP 67 (NEMA 4)	46 mm x 56 mm x 90 mm / IP 67 (NEMA 4)
Weight	320 g, incl. lens	320 g, incl. lens
Shock / vibration	25G, IEC 68-2-29 / 2G, IEC 68-2-6	25G, IEC 68-2-29 / 2G, IEC 68-2-6
Tripod mount	1/4-20 UNC	1/4-20 UNC
Power supply	USB powered	USB powered

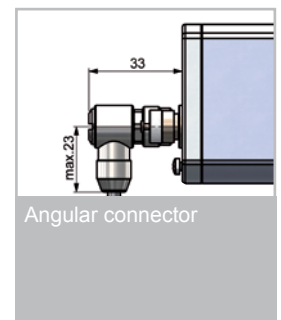
### Accessory for optris PI thermal imagers

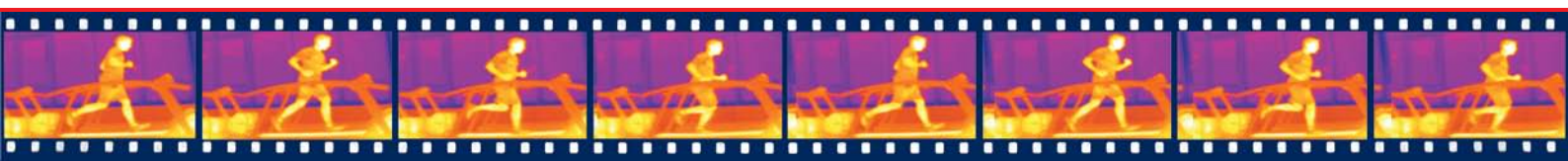

\* Not for PI200 / PI230 (BI-SPECTRAL camera versions)





### Extensive infrared camera software

- No additional costs
- No restrictions in licencing
- Modern software with intuitive user interface
- Remote control of camera via software
- Display of multiple camera images in different windows
- Compatible with Windows XP, Vista and 7, Linux (ubuntu) and LabVIEW\*

1.

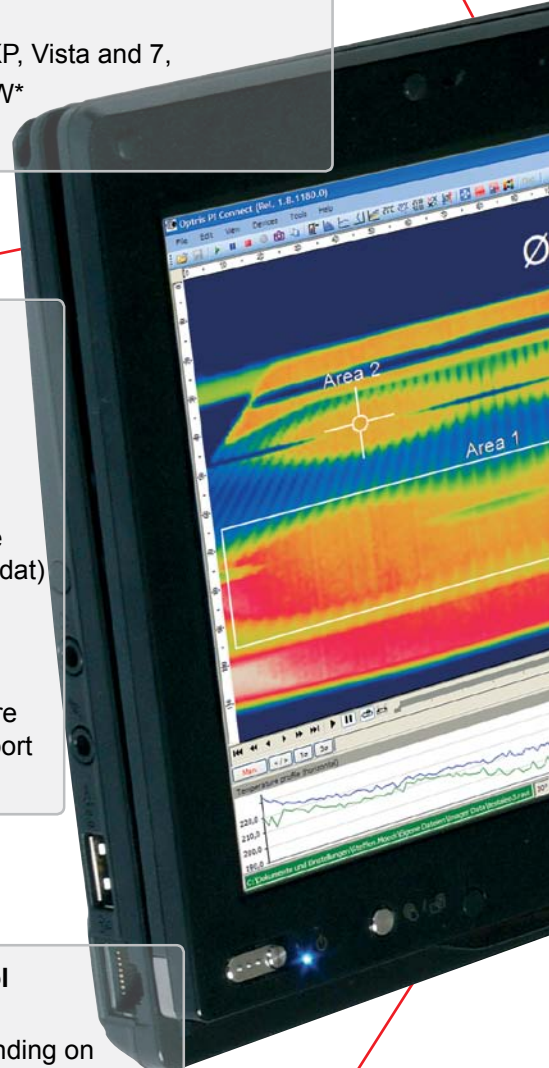

6.

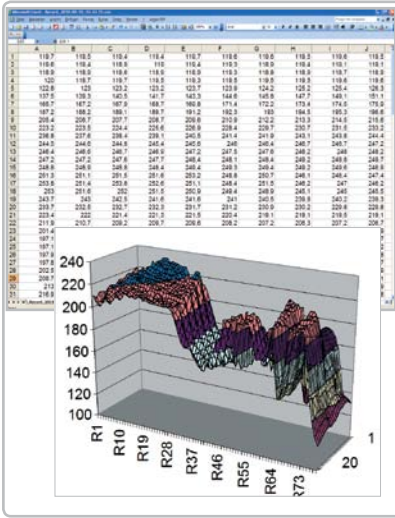

### Temperature data analysis and documentation

- Triggered data collection
- Radiometric video sequences (\*.ravi)
- Radiometric snapshots (\*.jpg, \*.tiff)
- Text files including complete temperature information for analysis in Excel (\*.csv, \*.dat)
- Data with color information for standard programs such as Photoshop or Windows Media Player (\*.avi, \*.jpg, \*.tiff)
- Data transfer in real time to other software programmes via LabVIEW, DLL or Comport interfaces

5.

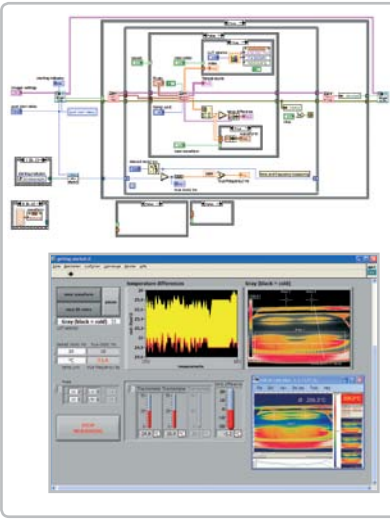

### Automatic process and quality control

- Individual setup of alarm levels depending on the process
- BI-SPECTRAL process monitoring (IR and VIS) for easy orientation at point of measurement
- Definition of visual or acoustic alarms and analog data output via the process interface
- Analog and digital signal input (process parameter)
- External communication of software via Comports, DLL and LabVIEW driver
- Adjustment of thermal image via reference values





**2. High level of individualization for customer specific display**

- Different layout options for an individual setup (arrangement of windows, toolbar)
- Temperature display in °C or °F
- Various language options including a translation tool
- Range of individual measurement parameter fitting for each application
- Adaption of thermal image (mirror, rotate)
- Individual start options (full screen, hidden, etc.)

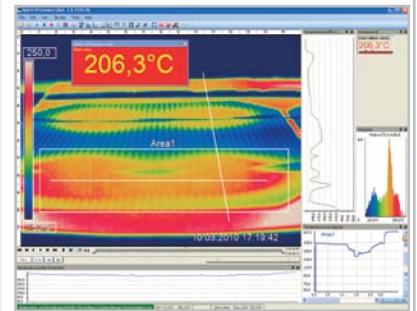

**3. Video recording and snapshot function (IR or BI-SPECTRAL)**

- Recording of video sequences and detailed frames for further analysis or documentation
- BI-SPECTRAL video analysis (IR and VIS) in order to highlight critical temperatures
- Adjustment of recording frequency to reduce data volume
- Display of snapshot history for immediate analysis

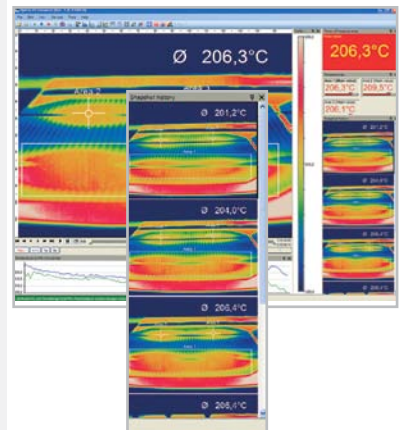

**4. Extensive online and offline data analysis**

- Analysis supported by measurement fields, automatic hot and cold spot searching
- Real time temperature information within main window as digital or graphic display
- Logic operation of temperature information (measurement fields and image substraction)
- Slow motion repeat of radiometric files and analysis without camera being connected
- Editing of sequences such as cutting and saving of individual images
- Various color palettes to highlight thermal contrasts

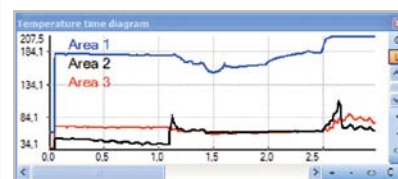
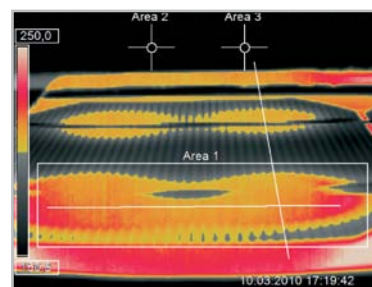

Example pictures: String soldering at solar cells

\*Windows is a registered trademark of Microsoft Corporation. LabVIEW is a registered trademark of National Instruments.



The optris PI Connect software comes with a linescanner function. The linescanner mode is generally used for **processes with moving objects** under test, such as measurement of rotary kilns or measurement of great lots at conveyor belts (batch process).

### Overview of the advantages:

1. Simple monitoring of process with limited optical access
2. Indirect visualization of heat distribution within ovens via camera installation at the oven exit
3. Extension of number of pixel from 160 pixel up to 200 pixel through use of picture diagonal
4. Up to 128 Hz data recording of unlimited lines which in turn can produce thermal images of any resolution
5. Up to 100° FOV as a line for detailed process analysis such as at wide conveyor belts



Application example: Rotary kiln within the chemical industry

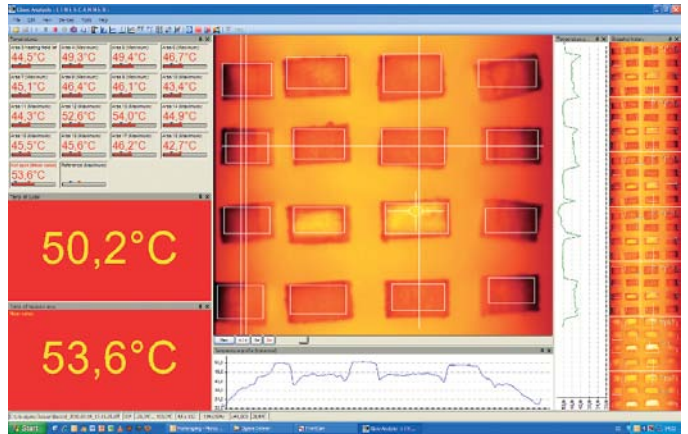

Layout example of linescanner function display

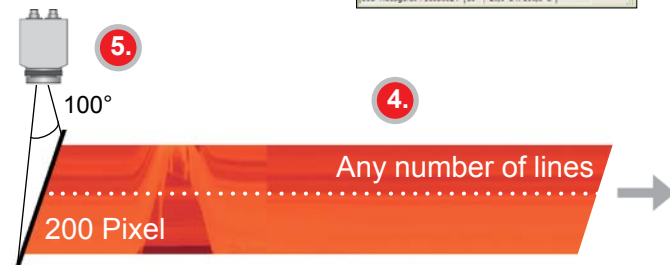
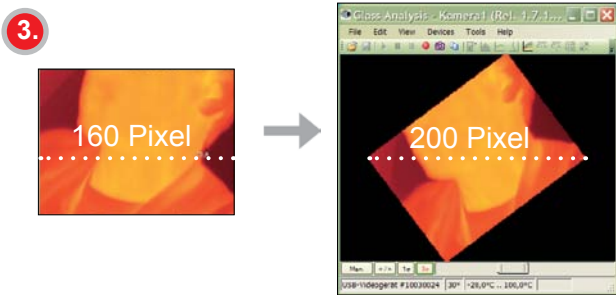
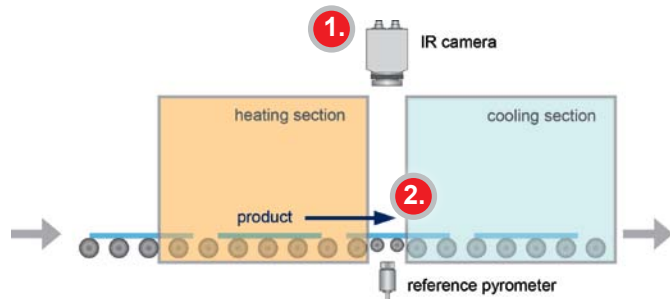

### Only three steps to initialize the function:

#### Step 1:

Activate the linescanner function and define the position of the line in the thermal image. The camera itself can be used for adjustment.

#### Step 2:

Setup of the linescanner function e.g. the number of displayed lines or the trigger definition for automatic picture storage.

#### Step 3:

Definition of individual layouts e.g. display of stored images in a snapshot history.

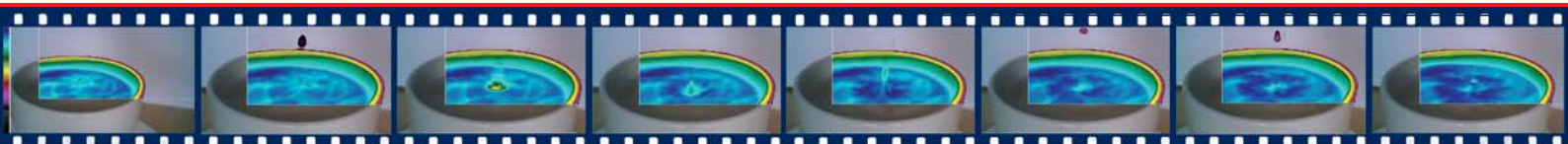

## Optical specification

The variety of different lenses offers the possibility to precisely measure objects in **different distances**.

We offer lenses for close, standard distances and large distances.

Different parameters are important if using infrared cameras. They display the connection between the distance of the measured object and the size of the pixel. When choosing a lens, the following data should be considered:

- **HFOV**: Horizontal enlargement of the total measuring field at object level
- **VFOV**: Vertical enlargement of the total measuring field at object level
- **IFOV**: Size of the single pixel at object level
- **DFOV**: Diagonal dimension of the total measuring field at the object level
- **MFOV**: Recommended, smallest measured object size of 3 x 3 pixel

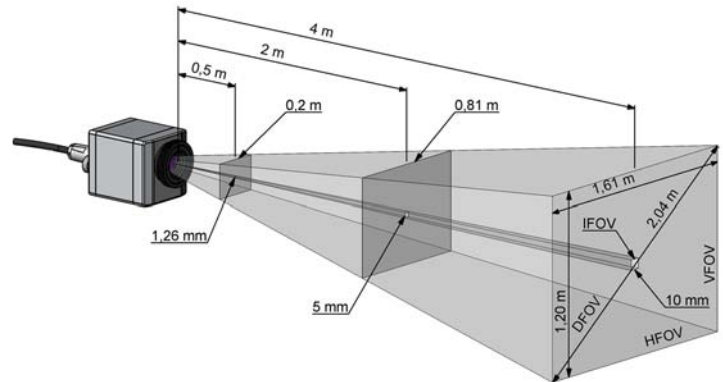

Measurement field sizes for any distances can be calculated online <http://www.optris.com/optics-calculator>.

Measurement field of the optris PI representing the 23° x 17° lens

PI 160/200/230 160 x 120 px	Focal length	Angle	Minimum distance*	Distance to object [m]												
					0.02	0.1	0.2	0.3	0.5	1	2	4	6	10	30	100
O23 Standard lens	10 mm	23° 17° 29° 2.52 mrad	0.2 m	HFOV [m]	0.008	0.04	0.08	0.12	0.20	0.40	0.81	1.61	2.42	4.0	12.1	40.3
				VFOV [m]	0.006	0.03	0.06	0.09	0.15	0.30	0.60	1.20	1.79	3.0	9.0	29.9
				DFOV [m]	0.010	0.05	0.10	0.15	0.26	0.51	1.02	2.04	3.06	5.1	15.3	51.1
				IFOV [mm]	0.1	0.3	0.5	0.8	1.3	2.5	5.0	10.1	15.1	25.2	75.6	252.0
O6 Tele lens	35.5 mm	6° 5° 8° 0.71 mrad	0.5 m	HFOV [m]					0.06	0.11	0.23	0.45	0.68	1.1	3.4	11.3
				VFOV [m]					0.04	0.08	0.17	0.34	0.50	0.8	2.5	8.4
				DFOV [m]					0.07	0.14	0.28	0.56	0.84	1.4	4.2	14.1
				IFOV [mm]					0.4	0.7	1.4	2.8	4.2	7.1	21.2	70.5
O48 Wide angle lens	5.7 mm	41° 31° 52° 4.72 mrad	0.2 m	HFOV [m]	0.015	0.08	0.15	0.23	0.38	0.76	1.51	3.02	4.53	7.6	22.7	75.6
				VFOV [m]	0.011	0.05	0.11	0.16	0.27	0.55	1.09	2.19	3.28	5.5	16.4	54.7
				DFOV [m]	0.019	0.10	0.19	0.29	0.49	0.97	1.95	3.90	5.85	9.7	29.2	97.5
				IFOV [mm]	0.09	0.5	0.9	1.42	2.4	4.7	9.5	18.9	28.3	47.2	141.7	472.3
O72 Wide angle lens	3.3 mm	72° 52° 95° 9.08 mrad	0.2 m	HFOV [m]	0.029	0.15	0.29	0.44	0.73	1.45	2.91	5.81	8.72	14.5	43.6	145.3
				VFOV [m]	0.020	0.10	0.20	0.29	0.49	0.98	1.95	3.90	5.85	9.80	29.3	97.5
				DFOV [m]	0.043	0.22	0.43	0.65	1.09	2.17	4.34	8.68	13.02	21.7	65.1	217.0
				IFOV [mm]	0.2	0.9	1.8	2.7	4.5	9.1	18.2	36.3	54.5	90.8	272.5	908.2

PI400/450 382 x 288 px	Focal length	Angle	Minimum distance*	Distance to object [m]												
					0.02	0.1	0.2	0.3	0.5	1	2	4	6	10	30	100
O38 Standard lens	15 mm	38° 29° 49° 1.81 mrad	0.2 m	HFOV [m]	0.014	0.07	0.14	0.21	0.35	0.69	1.39	2.77	4.16	6.9	20.8	69.3
				VFOV [m]	0.010	0.05	0.10	0.15	0.25	0.51	1.02	2.03	3.05	5.1	15.2	50.8
				DFOV [m]	0.018	0.09	0.18	0.28	0.46	0.92	1.84	3.68	5.52	9.2	27.6	92.0
				IFOV [mm]	0.1	0.2	0.4	0.5	0.9	1.8	3.6	7.3	10.9	18.1	54.4	181.3
O13 Tele lens	41 mm	13° 10° 17° 0.61 mrad	0.5 m	HFOV [m]					0.12	0.23	0.47	0.94	1.40	2.3	7.0	23.4
				VFOV [m]					0.09	0.17	0.35	0.70	1.05	1.7	5.2	17.5
				DFOV [m]					0.15	0.29	0.58	1.17	1.75	2.9	8.8	29.2
				IFOV [mm]					0.3	0.6	1.2	2.5	3.7	6.1	18.4	61.2
O62 Wide angle lens	8 mm	62° 49° 74° 3.14 mrad	0.5 m	HFOV [m]	0.024	0.12	0.24	0.36	0.60	1.20	2.40	4.80	7.20	12.0	36.0	119.9
				VFOV [m]	0.018	0.09	0.18	0.27	0.45	0.90	1.80	3.60	5.41	9.0	27.0	90.1
				DFOV [m]	0.030	0.15	0.30	0.45	0.75	1.50	3.00	6.00	8.99	15.0	45.0	149.9
				IFOV [mm]	0.1	0.3	0.6	0.9	1.6	3.1	6.3	12.6	18.8	31.4	94.2	314.0

Table with examples showing what spot sizes and pixel sizes will be reached in which distance. For individual configuration there are different lenses available. Wide angle lenses have a radial distortion due to their large opening angle; the software PIConnect contains an algorithm which corrects this distortion.

\*Note: The accuracy of measurement can be outside of the specifications for distances below the defined minimum distance.

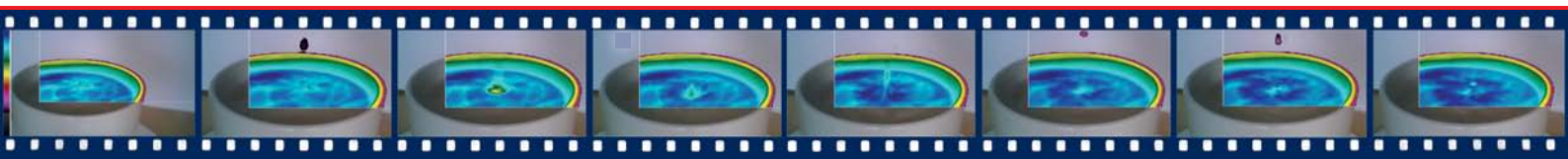



Inobalt UAB • H. Manto 84-310 • 92294 Klaipeda • Lithuania  
Tel.: +370 612 22499 • Email: rolandas@inobalt.lt  
Internet: www.inobalt.lt

